

SOLUTION 2000
MOTOR CONTROL CENTER



Power Transmission & Distribution





Being Created by Diversified Industrial Electricity Technology

Stabilized Power Supply and Maximization of Energy Efficiency

Where there is industry and electricity,

LS Industrial Systems always stands by your side.

The modular designed and type tested L. V Motor Control Center type SOLUTION 2000 satisfies the ever-increasing demand for high performance, high reliability, safe operation and versatility required in industrial facilities.

- Single and/or double (back to back) front construction.
- Variable width wire way up to 400 mm with protection against accidental touch.
- Combination of fixed and withdrawable units within the same cubicle.
- 3 ratings of plug-in contacts, 250A, 400A and 600A.
- Fully insulated riser busbar front barrier assembly.
- Protection against accidental touch of energized parts (IP20) without the need of automatic shutters.
- Accessible from front to the compartment for the modules and cabling way.
- Easy and simple rearrangement of module according to the operational requirements without danger and switching-off the switchboard.
- Can be equipped with up to 13 basic modules for motor control and 26 modules for MCCB up to 100A rating.



TECHNICAL DATA

Standard	Type tested LV switchgear and controlgear assembly(TTA) IEC 439-1 BS EN 60 439-1 AS 3439-1 Other national codes on request	
Rated voltage	600V AC	
Rated frequency	50/60Hz	
Main busbar (3/4poles)	Rated current	Up to 5000A (above 3000A double busbar)
	Rated short time withstand current(1s)	Up to 80kA
	Peak withstand current	Up to 176kA
Vertical busbar (3/4poles)	Rated current	1000A, 1500A
	Rated short time withstand current(1s)	Up to 80kA
	Peak withstand current	Up to 176kA
Vertical control bar (2poles, up to 4poles)	Rated current	80A at 380V
Arcing due to internal fault	Tested according to the AS 3439-1, appendix EE	
Degree of protection	IP 40 for casing IP 20 for compartment	
Overall dimension	Height : 2300mm/ 2200mm Width : 1000mm/ 900mm Depth : 650mm / 1000mm(Duplex)	
Thickness of material	Frame : 2.3mm Door / Cover : 1.6mm (2.3mm as option) Top and side plate : 1.6mm	
Coating	Frame : LH-AH086-1 / Dark blue Door/Cover : LH-RANTONE 420C / Light Yellow Unit and others : hot dip galvanized steel	
Wiring	Main : KIV 3.5mm ² as a minimum with black color Control : KIV 1.25mm ²	
Name plate	Material : Acrylic Letter : Gothic, Black Background : White	

MAIN BUSBAR

Main busbars are mounted at the upper and/or middle part of the cubicle.
Main busbar compartment is structurally isolated from unit compartment and cable way to ensure safety.

VERTICAL BUSBAR

The vertical riser covered with arc proof is in the rear of module compartment.
The plug-in openings finger proof can be covered with automatic shutters as option.

MAIN BUSBAR SIZE (mm²)

A	Phase (A,B,C)	Neutral (N)	Earth (PE)
1000	75 × 10	40 × 10	40 × 10
1600	100 × 10	40 × 10	40 × 10
2000	2-75 × 10	75 × 10	50 × 10
2500	2-100 × 10	75 × 10	50 × 10
3150	2 × (2-75 × 10)	2-50 × 10	50 × 10
4000	2 × (2-100 × 10)	2-75 × 10	50 × 10
5000	2 × (2-100 × 10)	2-75 × 10	50 × 10

VERTICAL BUSBAR SIZE (mm²)

A	Phase (A,B,C)	Neutral (N)	Earth (PE)
1000	72 × 6	40 × 6	40 × 6
1500	72 × 6+40 × 6	40 × 6	40 × 6

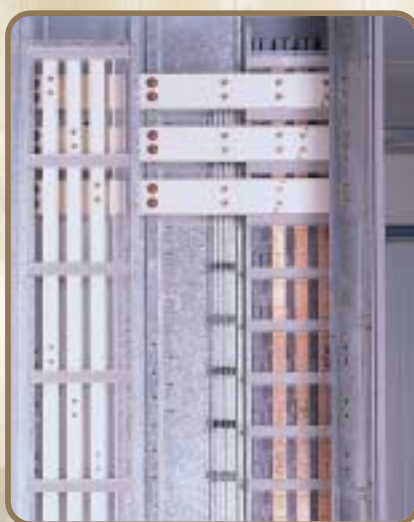

Main and vertical busbar compartment

UNIT

The height of drawable unit ranges from minimum 150mm to maximum 1050mm. The height is increased by 150mm pitches. MCCB, electro-magnetic switches, motor protection relay, auxiliary relays, timer, CT, ZCT, and fuses are placed at the point of unit while main circuit's draw-out plug and control power plug, safety shutter opening guide are situated in the rear. Main circuit's secondary draw-out plug and control plug are installed on the right side of unit.



Internal view



View into the cable compartment



View into



the unit compartment

Service position
 Test position
 Draw-out position



Control and indication

Operation and indication elements are mounted on the front plate of the unit

UNIT POSITION

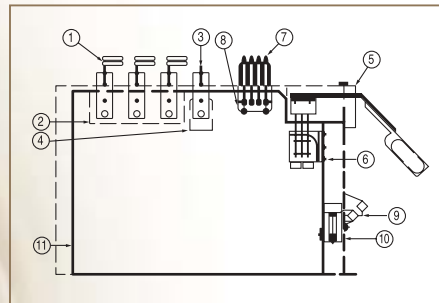

● **SERVICE POSITION**

Main circuit's primary and secondary draw-out plugs, control power plug, control circuit draw-out connector are connected to the power source and load side components while the unit locking device is in the locked position. If locking is not effected securely, the unit might have been positioned incorrectly.

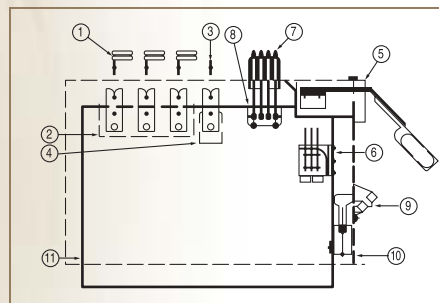

● **TEST POSITION**

Only control power plug and control circuit draw-out connector are connected to the control power source for the test operation. In this position, all output control signals can be checked through the control circuit connector.

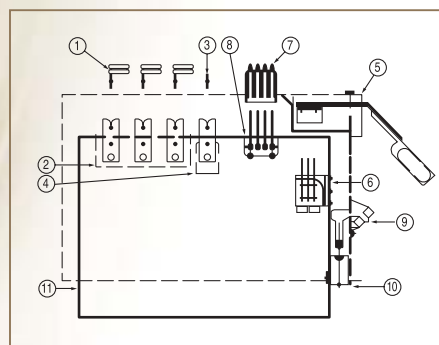

● **DRAW-OUT POSITION**

Main circuit's primary and secondary draw-out plugs, control power plug, control circuit draw-out connector are disconnected in this position. The unit can be completely drawn-out from the cubicle.

- ① Vertical busbar
- ② Power plug for line side
- ③ Neutral busbar
- ④ Power plug for neutral
- ⑤ Fixed-power plug for load side
- ⑥ Movable power plug for load side

- ⑦ Control power busbar
- ⑧ Control power plug
- ⑨ Plug for control circuit
- ⑩ Socket for control circuit
- ⑪ Draw-out unit

STARTER ARRANGEMENT

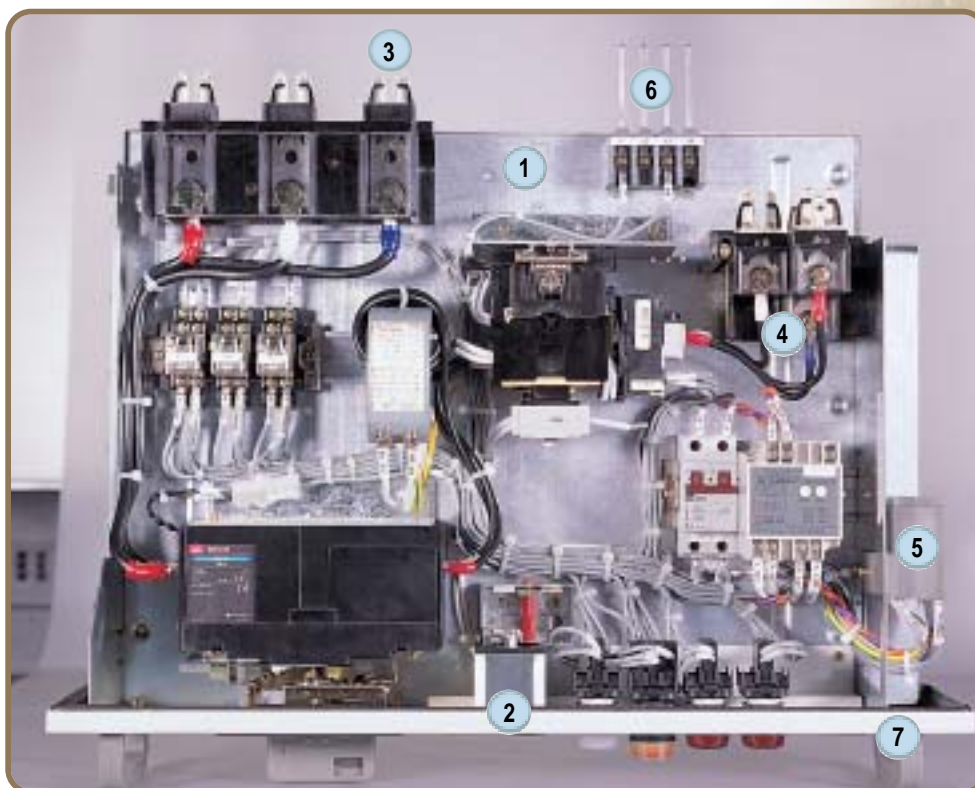

- ① Module base plate
- ② Position locking device
- ③ Power plug (line side)
- ④ Power plug (load side)
- ⑤ 24-pole control plug, connected in cable compartment
- ⑥ 4-pole control power plug, connected to the control busbars
- ⑦ Cover for operation and indication

VIEW OF FRONT COVER

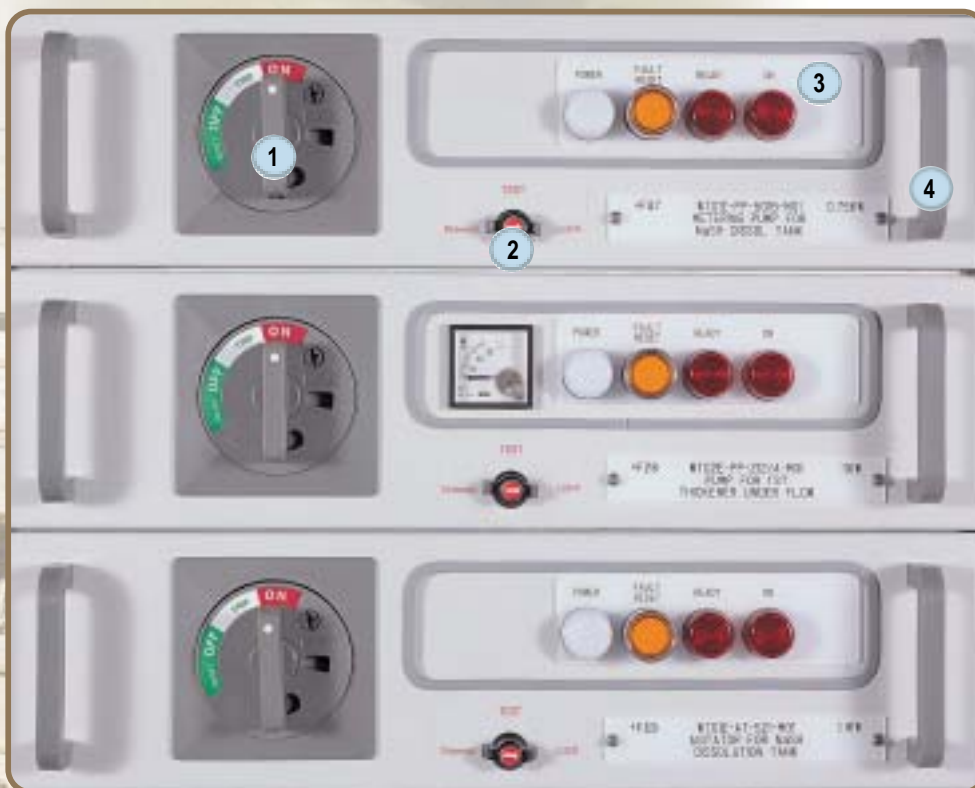

- 1 MCCB operating handle (Pad lockable in OFF-position)
- 2 Position locking device
- 3 Operation and indication plate
- 4 Draw-out handle

OVERALL VIEW



STRUCTURE

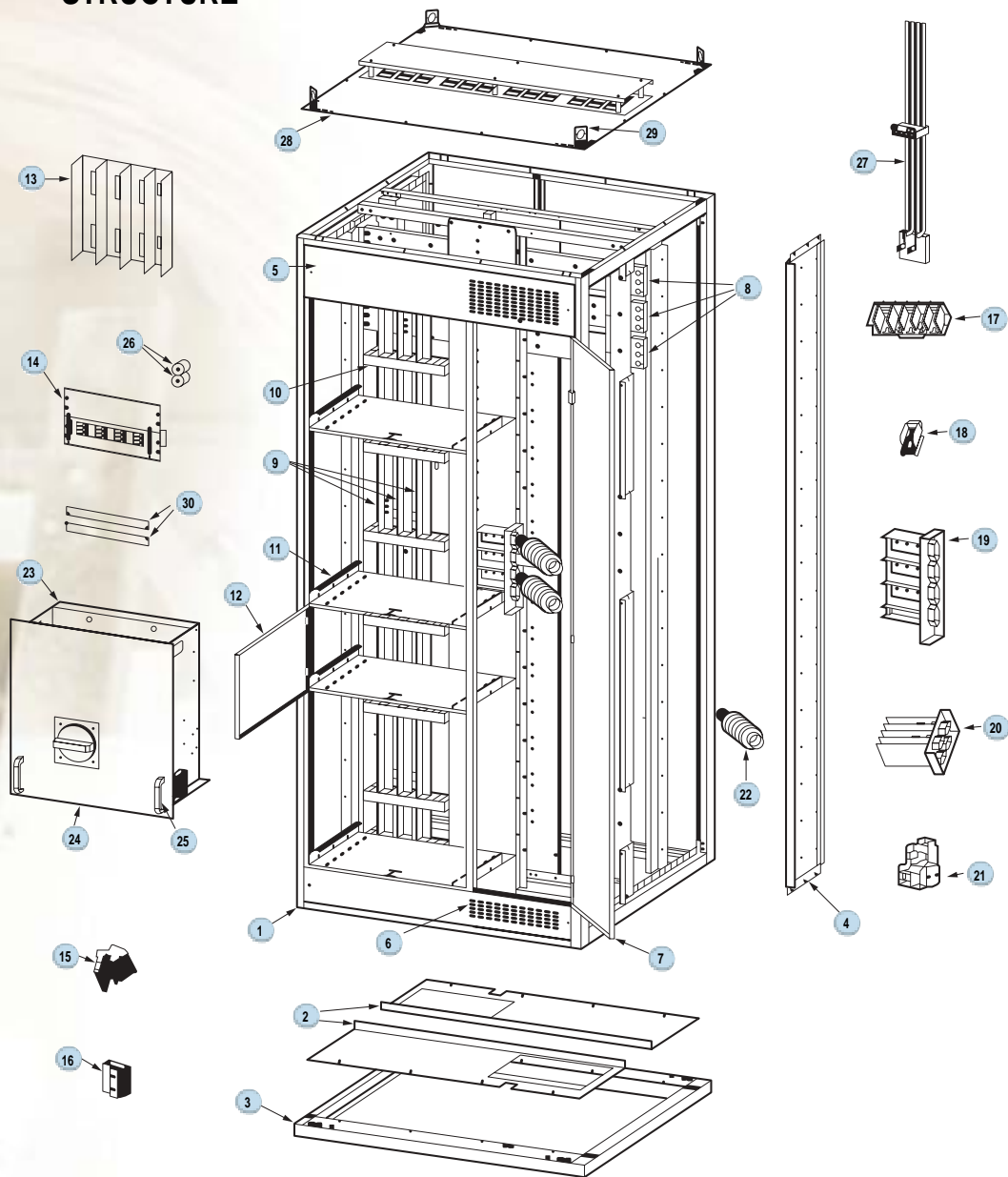

- | | | |
|-------------------------------|-----------------------------------|-----------------------------------|
| 1 Basic frame | 11 Partition plate | 21 Power plug for load side(125A) |
| 2 Bottom plate | 12 Door | 22 Sleeve for cable protection |
| 3 Channel base | 13 Arc proof barrier | 23 Module |
| 4 Cable compartment partition | 14 Finger proof barrier | 24 Front cover |
| 5 Upper front cover plate | 15 Plug for control circuit | 25 Draw-out handle |
| 6 Lower front cover plate | 16 Socket for control circuit | 26 Insulator power busbar |
| 7 Door for cable compartment | 17 Power plug for line side | 27 Control power busbar |
| 8 Main busbars | 18 Power plug for neutral | 28 Top plate |
| 9 Vertical busbars | 19 Power plug for load side(600A) | 29 Lifting lug |
| 10 Vertical busbar clamp | 20 Power plug for load side(250A) | 30 Safety shutter |

STANDARD SPECIFICATION CODE

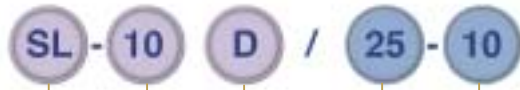

Vertical Busbar : 10=1000A 15=1500A
 Main Busbar : 10=1000A, 16=1600A, 20=2000A
 25=2500A, 30=3000A, 40=4000A
 D=Double Front Type, S=Single Front Type
 10=Cubicle Width (1000mm), 09=Cubicle Width (900mm)
 SOLUTION 2000 MCC

DOUBLE FRONT TYPE

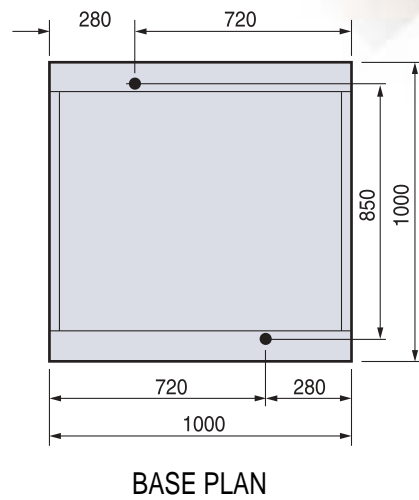
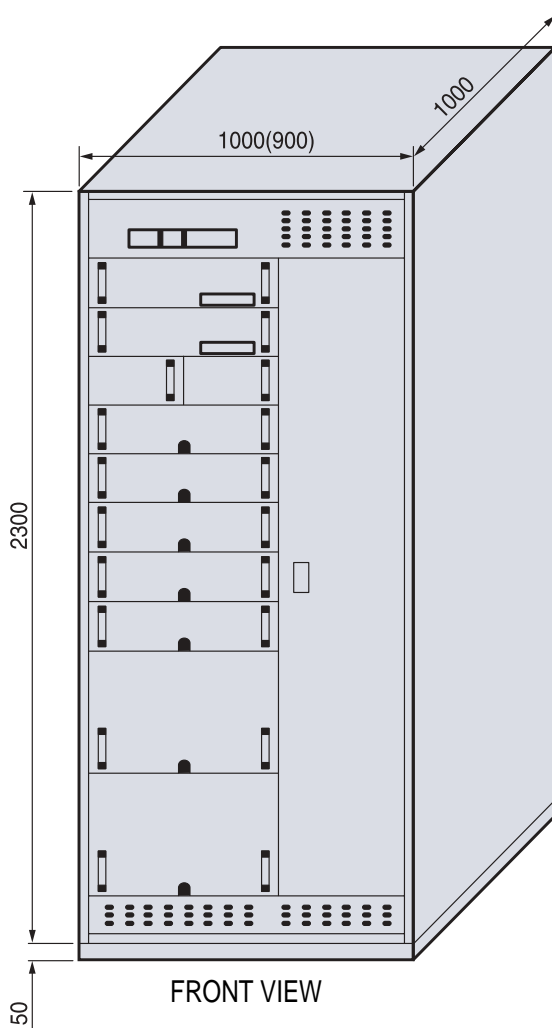



SINGLE FRONT TYPE

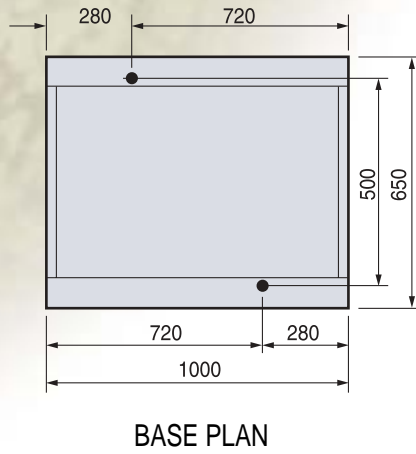
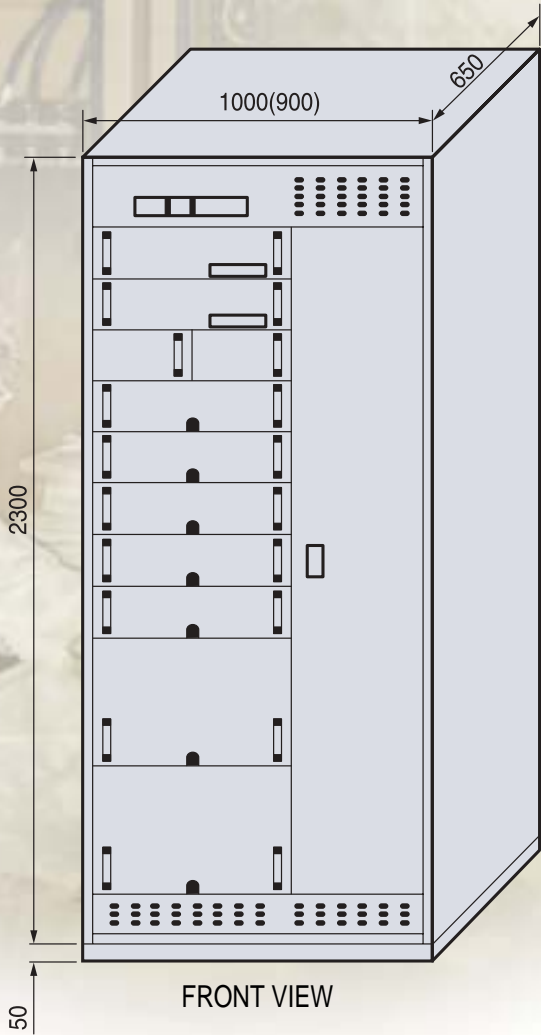

BASIC INSTALLATION DRAWING OF SOLUTION 2000 MCC

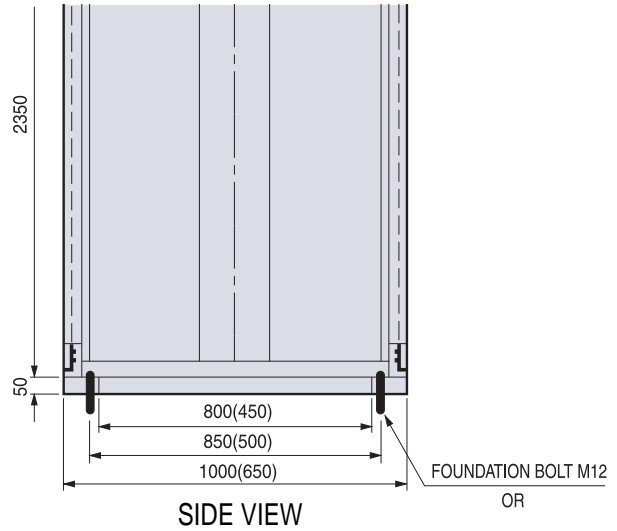
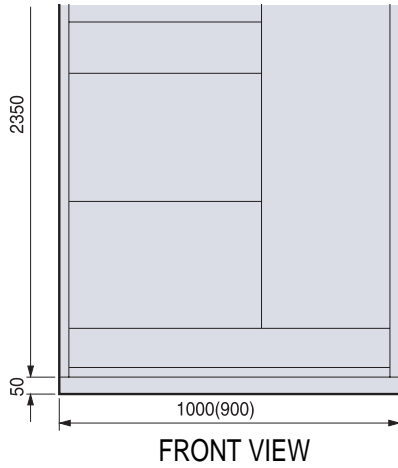

FIXED BY WELDING

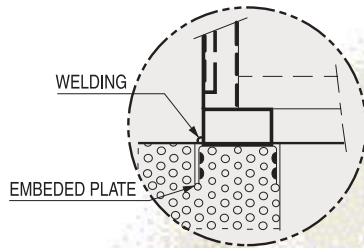

FIXED BY BOLTS

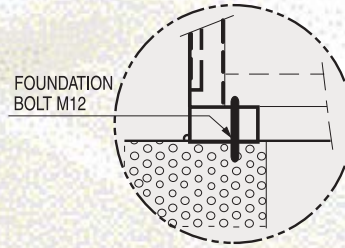

**DOUBLE FRONT TYPE
PLANE VIEW OF BOTTOM**

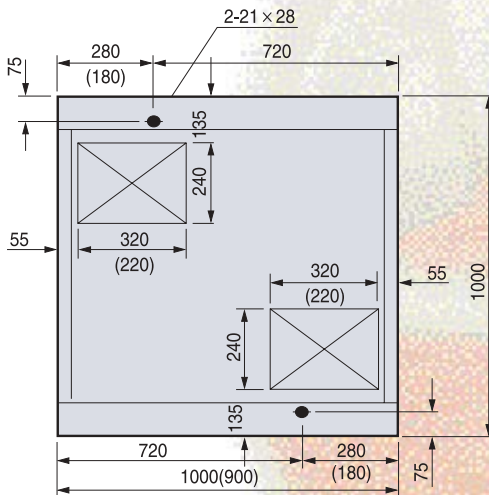

**SINGLE FRONT TYPE
PLANE VIEW OF BOTTOM**

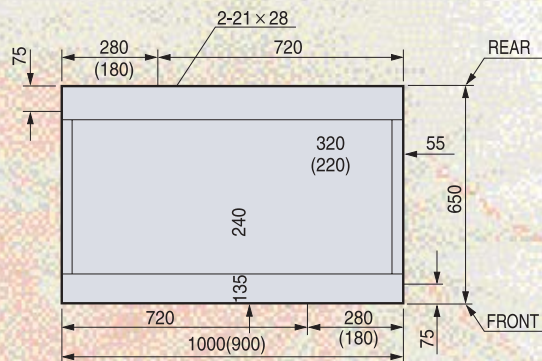

NOTE

1. A side plate is installed at the end of the line-up.
2. The installation of MCC having bottom cable entries requires foundation with an opening of a cable duct.
3. The horizontal tolerance of the level should not exceed $\pm 1\text{mm}$ over length of 1 meter.
4. The MCC can be welded or screwed to the foundation frame.
5. The maximum number of cubicles for transportation is 2.

STANDARD UNIT APPLICATION TABLE

Motor capacity(kw)		Rated Current	MCCB Type	Mag. Contactor	Thermal Relay	A-CT		UNIT SIZE			Wire used (mm ²)	Remarks
440V	220V					Ammeter Scale	CT (15VA)	NON-Reversible	Reversible	Y- δ		
0.2	-	0.5-0.8										1. Unit size is inclusive of 2 auxiliary relays (NOTE 3) 2. If NEMA size is applied to electro-magnetic contactor, the unit size can be changed.
0.4/0.54	0.2	0.8-1.7				0~5	5:5					
0.75	-	1.3-1.9										
1.1	0.4/0.54	1.7-2.8										
1.5	0.75	2.7-3.9		CH-5	TH-5N							
2.2	1.1	3.8-4.9		SMC-20P		0~10	10:5				5.5 (3.5)	
3.7	1.5	5.3-7.5				0~15	15:5	H1(150)	H2(300)	H2(300)		
-	2.2	7.6-9.3				0~20	20:5					
5.5	-	9~11	ABL 53a or			0~30	30:5					
7.5	3.7	12~15	ABL 103a			0~20	20:5					
11	5.5	18~22		CH-6N SMC-25P		0~30	30:5					
15	7.5	24~29.3		CH-7.5N SMC-35P		0~50	50:5			14		
18.5	-	30~34			TH-1015N							
22	11	35~42		CH-10N SMC-50P								
30	15	48~56		CH-15N SMC-65P		0~75	75:5	H2(300)	H3(450)	H3(450)	22	
37	18.5	59~67		SMC-80P	TH-20N							
45	22	70~80		GMC-100	GTH-100	0~100	100:5	H3(450)	H4(600)	H4(600)	38	
55	30	89~108	ABL 203a	GMC-125	GTH-150	0~150	150:5				60	
75	37	117~134		GMC-150		0~200	200:5	H4(600)	H5(750)	H5(750)	80	
90/110	45/55	141~196		GMC-220	GTH-220	0~300	300:5	H5(750)	H6(900)	H6(900)	2 i 80	
125	-	195~223	ABH 403a			0~400	400:5				2 i 100	
150	75	235~268		GMC-300	GTH-400							

NOTE

- The table is based on E-class insulation, 4 Pole closed-type low-voltage cage motor.
- MCCB model can be changed according to breaking capacity of the system (The standard table is based on 65kA)
- Applies to cases where there is no control transformer and there is two auxiliary relays.

Leader in Electrics & Automation



Safety Instructions

- For your safety, please read user's manual thoroughly before operating.
- Contact the nearest authorized service facility for examination, repair, or adjustment.
- Please contact qualified service technician when you need maintenance.
Do not disassemble or repair by yourself!
- Any maintenance and inspection shall be performed by the personnel having expertise concerned.

LS Industrial Systems Co., Ltd.

www.lsis.biz

■ HEAD OFFICE

Yonsei Jaedan Severance Bldg. 84-11 5ga, Namdaemun-ro,
Jung-gu Seoul 100-753, Korea
Tel. (82-2)2034-4721/35 Fax. (82-2)2034-4755

■ Global Network

- **LS Industrial Systems Tokyo Office >> Japan**
Address: 16F, Higashi-Kan, Akasaka Twin Towers 17-22, 2-chome, Akasaka,
Minato-ku Tokyo 107-8470, Japan
Tel: 81-3-3582-9128 Fax: 81-3-3582-0065 e-mail: dongjins@lsis.biz
- **LS Industrial Systems Dubai Rep. Office >> UAE**
Address: P.O.Box-114216, API World Tower, 303B, Sheikh Zayed road,
Dubai, UAE.
Tel: 971-4-3328289 Fax: 971-4-3329444 e-mail: hwyim@lsis.biz
- **LS-VINA Industrial Systems Co., Ltd. >> Vietnam**
Address: LSIS VINA Congty che tao may dien Viet-Hung Dong Anh Hanoi,
Vietnam
Tel: 84-4-882-0222 Fax: 84-4-882-0220 e-mail: srjo@hn.vnn.vn

- **LS Industrial Systems Hanoi Office >> Vietnam**
Address: Room C21, 5Th Floor, Horison Hotel, 40 Cat Linh, Hanoi, Vietnam
Tel: 84-4-736-6270/1 Fax: 84-4-736-6269
- **Dalian LS Industrial Systems Co., Ltd. >> China**
Address: No. 15 Liaohehexi 3 Road, Economic and Technical Development zone,
Dalian, China
Tel: 86-411-8273-7777 Fax: 86-411-8730-7560 e-mail: lixk@lgis.com.cn
- **LS Industrial Systems International Trading (Shanghai) Co., Ltd. >> China**
Address: Room 1705-1707, 17th Floor Xinda Commercial Building No 322,
Xian Xia Road Shanghai, China
Tel: 86-21-6278-4291 Fax: 86-21-6278-4372 e-mail: xuhg@lgis.com.cn
- **LS Industrial Systems (Wuxi) Co., Ltd. >> China**
Address: 102-A National High&New Tech Industrial Development Area,
Wuxi, Jiangsu, China
Tel: 86-510-534-6666 Fax: 86-510-522-4078 e-mail: Xuhg@lgis.com.cn
- **LS Industrial Systems Beijing Office >> China**
Address: Room 602, North B/D EAS, 21 Xiao Yun Road, Dongsanhuan Beilu,
Chaoyang District Beijing 100027, China
Tel: 86-10-6462-3254 Fax: 86-10-6462-3236 e-mail: linsz@lgis.com.cn
- **LS Industrial Systems Guangzhou Office >> China**
Address: Room 1403, 14F, New Poly Tower, 2 Zhongshan Liu Road, Guangzhou,
China
Tel: 86-20-8326-6754 Fax: 86-20-8326-6287 e-mail: zhangch@lgis.com.cn
- **LS Industrial Systems Chengdu Office >> China**
Address: Room 2907, Zhong Yin B/D, No. 35, RenminZhong(2)-Road, Chengdu,
China
Tel: 86-28-8612-9151 Fax: 86-28-8612-9236 e-mail: hongkonk@vip.163.com
- **LS Industrial Systems Qingdao Office >> China**
Address: 7B40, Haixin Guangchang Shenye Building B, No. 9,
Shandong Road Qingdao, China
Tel: 86-532-580-2539 Fax: 86-532-583-3793 e-mail: bellkuk@hanmail.net

Specifications in this catalog are subject to change without notice due to continuous product development and improvement.